

# V1631MN-F SERIES

HD 2MP EXPLOSION-PROOF IP PTZ CAMERA SYSTEM

**Infinova**<sup>®</sup>

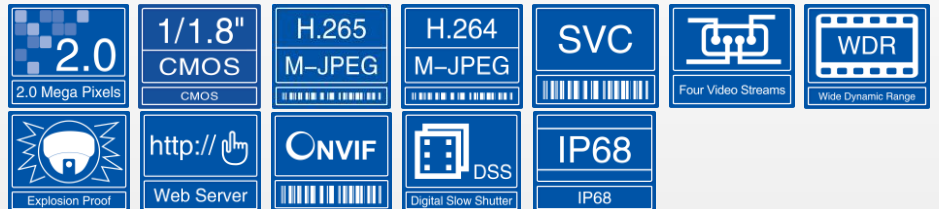

## FEATURES

- The chip is integrated with TPU module, and supports video structuration function based on deep learning algorithm.
- 316/316L stainless steel construction, IP68 environmental rating
- Strong corrosion-resistant capabilities
- HD network video output: 1920x1080@60fps
- Built-in 30X HD integrated camera module
- 1/1.8\"/>
- Ultra-low illumination: 0.0005 lux
- Supports frame integration WDR, with dynamic range up to 120dB
- H.265/H.264/M-JPEG/SVC video encoding, quad video streams
- Features rich smart functions such as video anomaly detection, behaviour-analysis detection, sound detection, statistics detection, intelligent grouping detection
- Support multi-target detection, tracking and snapshot; support optimum selection and duplicate removal for captured structured images; small face images and panoramic images are optional to be uploaded to platforms for secondary analysis and retrieval.
- Support structured object attributes: able to detect face, pedestrian, motor vehicle and non-motor vehicle. Supports vehicle-pedestrian mode and vehicle mode
- Up to 8 ROI (Region of Interest) areas.
- Onvif Profile S/G/T and RTSP compliant
- Bi-directional audio, G.711-A/G.711-U/AAC /G.726 standard optional
- 2 alarm inputs, 1 on-off output
- Support remote PTZ control
- Support area zoom, image PTZ and E-zoom
- Support preset, pattern, auto-pan, tour and home return, etc.
- IP68 rating
- Built-in with wiper
- 360° Pan/Tilt rotation at 0.05°~20°/s

# DESCRIPTION

V1631MN-F series HD 2MP explosion-proof integrated IP PTZ camera is fully-developed and specially designed for use in flammable and explosive hazardous areas. The system uses 316/316L stainless steel to ensure its good explosion-proof performance in hazardous areas. It has an absolute operating temperature range of -40°F~140°F (-40°C~60°C). This camera is properly sealed to prevent the intake of flammable dust and ensure strong corrosion-resistant capabilities.

The camera has a built-in HD integrated camera module, utilizes large size progressive scanning CMOS sensor and has an internal 30X optical zoom lens. It provides high quality video with the resolution up to 1920x1080@60fps, adopts H.265/H.264/M-JPEG /SVC compression formats, outputs four video streams and boasts of excellent resolution and color reproduction ability to ensure richer and more accurate details to be acquired and also guarantee the accuracy of intelligent analysis in a more effective way.

Based on deep-learning algorithm, V1631MN-F series HD network explosion proof camera is endowed with vivid smart functions and video structuring functions such as face detection, pedestrian detection, motor vehicle detection and non-motor vehicle detection. It's able to output target attributes and images to the backend platform for big data analysis, which effectively reduces loads and costs of smart analysis and handling that the control platform bears.

The user-friendly GUI interface is designed for easy PTZ control and convenient camera parameter settings. Thus, it makes easier to set the PTZ and perform operations with a mouse than traditional keyboard. In addition, area zoom and image PTZ are also offered. The intelligent motion detection and multiple alarm responses make it even safer to use.

All products shall meet the provisions of standard Ex db IIC T6 Gb (-40 °C ≤ Ta ≤ +60 °C)/ Ex tb IIIC T80°C Db (-40 °C ≤ Ta ≤ +60 °C) IP68 (For IPX8: 1.5 meter & 2 hours)

V1631MN-F series cameras also provide functions such as preset, pattern, auto pan, auto scan and normal tour, etc. V1631MN-F series allows 360° continuous pan/tilt rotation at the speed of 0.05~20°/s. An optoelectronic device is embedded to detect the position of camera housing. It will send signals to the processor when the camera housing is turned upside down. Then, the processor sends an order to flip the image for normal view.

# TECHNICAL SPECIFICATIONS

<b>Lens (Visible)</b>	
Image Sensor	1/1.8" Progressive scan CMOS
Optical Zoom	30X
Digital Zoom	-
Focal Length	f=6~180mm
Iris	F1.6~F4.8
Focus	Auto, Manual, M/A; supports to set focal length
FOV(H/V/D)	H:59.8°-3.0°V:44.4°-2.24°; D:70°-3.76°
Lens Mount	-
<b>Lens (Thermal)</b>	
Imager Type	-
Lens Type	-
Spectral Band	-
Pixel Size	-
NETD	-
Focal Length	-
FOV	-
<b>Video</b>	
Camera Resolution (Visible Lens)	2MP
Max. Coding Capacity (Visible Lens)	Major stream: H.264/H.265 -60fps@1920x1080 Minor stream: H.264/H.265 -30fps@1920x1080 Third stream: H.264/H.265 -30fps@384x256 Fourth stream: H.264/H.265 -30fps@384x256 Major stream: H.264/H.265 -60fps@1920x1080 Minor stream: H.264/H.265 -30fps@1920x1080 Third stream: MJPEG -30fps@1920x1080 Fourth stream: H.264/H.265 -30fps@384x256

Max. Coding Capacity (Thermal Lens)	-
Data Rate	VBR/CBR Major stream: 128kbps~10240kbps Minor stream: 128kbps~4096kbps Third stream: 128kbps~512kbps Fourth stream: 128kbps~512kbps
Video Compression	H.265/H.264/M-JPEG/SVC independent coding
Multi-Streaming	Four stream independent output
Video Rotation	Video can be rotated by 0°, 90°, 180°, 270°
<b>Audio</b>	
Audio Compression	G.711-A/ G.711-U/ G.726/ AAC
Sample Rate	8KHz (for G.711-A/G.711-U/G.726), 16KHz, 32KHz, 44.1KHz and 48KHz (for AAC)
Audio Interface	1 input, Linear level, 1 output, Linear level
Two-way Audio	Available
Mic & Speaker	-
<b>Image</b>	
Shutter	Auto/Manual (1/1s ~ 1/32000s)
WDR	Up to 120dB
Exposure	Auto/Manual/Shutter
Sensitivity	Color mode: 0.005lux @F1.6 (AGC ON) B/W mode: 0.0005lux @F1.6 (AGC ON)
White Balance	Auto/Manual/Outdoor
Video Adjustment	Brightness, contrast, saturation, hue, sharpness
Noise Reduction	3D

# TECHNICAL SPECIFICATIONS

S/N Ratio	>62dB
Defog	Available
EIS	Available
Mirror	Vertical/Horizontal
Corridor Mode	-
Day/Night Switching	ICR
AGC	Available, 64 level adjustable
BLC	Available
HLC	Available
Privacy Mask	Up to 4 definable zones
ROI	Up to 8 definable zones
OSD	Supported
<b>Pan/Tilt Functions</b>	
Preset	1024
Pattern	12
Autopan	12
Normal Tour	16 (each tour can be associated with 14 acts, including Preset 1~32, Pattern 1~4, Auto pan 1~4)
Home Return	Available
Timing Tour	Available
Autoscan	Available
Area Zoom	Available
<b>IR Illumination</b>	
Smart-IR	-
Wave Length	-
Night Vision Distance	-
<b>Temperature Measurement</b>	
Screening Function	-
Measurement Distance	-
Measurement Range	-
Accuracy	-
<b>Smart Analytics</b>	
Video Analytics	<p>Video Anomaly Detection - Camera tampering, camera shifting, defocus detection, high brightness detection, low brightness detection, video loss detection, color cast detection, and motion detection</p> <p>Behaviour Analysis Detection - Wire crossing detection, intrusion detection, object abandoned detection, object lost detection, loitering detection, crowd detection, fast moving detection and target fall detection</p> <p>Sound Detection - Abnormal sound detection and fight detection</p> <p>Statistics Detection - Counting, density detection, queue length detection and dwelling detection</p> <p>Intelligent Grouping Detection - Structurized face detection grouping, behaviour analysis grouping, and people and vehicle coexistence detection grouping, PTZ tracking grouping</p> <p>Multi-object detection - Support face, pedestrian, motor vehicle, and non-motor vehicle detection</p> <p>Capture - Support target detail capture</p> <p>Optimum Selection - Support optimum selection and duplicate removal for captured images to deliver the best-quality images</p> <p>Video Structurization - Support structurized object attributes: - Face attributes: gender, glasses, eyes open, mask, mouth open and facial</p>

Video Analytics	<p>expression (angry, disgusted, fearful, happy, sad, surprised or neutral) - Pedestrians attributes: gender, age (youth, middle-aged, elderly or teenager), top style (long sleeve, short sleeve, robe or trench coat, stripe, logo, plaids, matching or splicing), top color (white, black, red, yellow, grey, blue, green, dark grey or purple), bottom style (long pants, shorts, skirt, stripes or patterns), bottom color (white, black, red, yellow, grey, blue, green, dark grey or purple), glasses, hat, backpack, shoulder bag, holding kids, objects in hand, protective clothing, safety helmet, direction (front, back, side) - Motor vehicle attributes: Types (car, tricycle, truck, pickup trucks, van, bus), vehicle brands, vehicle body color (black, blue, brown, green, grey, white, red, yellow, pink, purple, dark grey, silver, orange, green and other), license plate number, license plate color (yellow, blue, black, white and green), license plate types (small car plate, large car plate, new energy vehicle license plate, large truck or trailer license plate), direction(front, rear, left, right, left front, right front, left rear and right rear) - Non-motor vehicle attributes: type (bicycle, motorcycle), equipped with umbrella, helmet, overload, direction (front, rear, left, right, left front, right front, left rear and right rear). PTZ tracking - Support human tracking; Supports capturing human body and human face during the tracking process</p>
<b>Storage</b>	
Storage Slots	Support a single card
Built-in Storage	Up to 512GB
NAS Storage	-
Local PC Recording	Available
<b>Alarm</b>	
Alarm Ports	2 alarm inputs, 1 on/off output
Alarm Input	I/O input, motion detection, smart alarm, network disconnection, SD card removal, heartbeat loss
Alarm Association	I/O output, email, FTP upload, audio, SD card recording and SD card snapshot
<b>System Functions</b>	
Operating System	Win7 and higher versions
Browser	IE8 and higher versions
Access Protocol	ONVIF Profile S/G/T, CGI 2.7
Multiple Access	Up to 20-ch simultaneous access
Web Server	Available
Remote Upgrade	Available
Password Protection	Available
RS485 Port	Available
Analog Video Output	Available
Maximum Number of Users	64, with 3 types of users available: administrator, normal user, and operator
Wiper	Available
<b>Network</b>	
Network Interface	1*RJ45 10/100M self-adaptive Ethernet port
Network Protocols	IPv4/IPv6, TCP, UDP, IGMP, ICMP, IGMPv3/3, DHCP, SNMP (V1, V2, V3), FTP, SMTP, NTP, RTC, RTP, RTSP, RTCP, HTTP, HTTPS, SSL, 802.1x, QoS, PPPoE, DNS, DNSv6, DDNS, ARP, UPnP, IP Filter, TLS, DES, Multicast, SIP

IP Address Filtering	Support blacklist and whitelist filtering
Network Delay	<300ms
<b>Environmental</b>	
Anti-Static	Air discharge: 8KV, contact protection: 6KV (for all ports)
Surge Protection	Difference mode: ±1KV, common mode: ±2KV (for network port and power port)
Operating Temperature	-40°F~140°F (-40°C~+60°C)
Storage Temperature	-40°F~158°F (-40°C~+70°C)
Operating Humidity	≤ 95% RH
Environmental Rating	IP68 (1.5m/2h)
Impact Resistance	IK10
<b>Mechanical</b>	

Manual Speed	Pan: 0.05°/s ~ 30°/s; Tilt: 0.05°/s ~ 30°/s
Preset Speed	0.05°/s ~ 30°/s
Rotation Angle	Pan: 360°; Tilt: 360°
Preset Accuracy	±0.1°
Electric Motor	Stepping motor
<b>Electrical</b>	
Power Supply	100~240VAC 500mA
Power Consumption	50W
<b>Physical</b>	
Product Dimension (L×W×H) or (H x D)	372.4mm×353.9mm×400.5mm (length × width × height)
Package Dimension (L x W x H)	740mm×740mm×470mm
Unit Weight	84 lbs. (38±5%kg)
Shipping Weight	121 lbs. (55±5%kg)
<b>Certifications</b>	
Product Certifications	IECEX; CCOE/PESO; CE; FCC; IK10; IP68; RoHS

## ORDERING INFORMATION

V1631 MN-30F29A-2	HD Megapixel Explosion-proof IP PTZ Camera System, 2MP, 30X, 1/1.8" CMOS, Day/night, H.265/H.264/M-JPEG/SVC, 316 Stainless Steel, With audio alarm, 100~240VAC
V1631 MN-30F29A-3	HD Megapixel Explosion-proof IP PTZ Camera System, 2MP, 30X, 1/1.8" CMOS, Day/night, H.265/H.264/M-JPEG/SVC, 316L Stainless Steel, with audio alarm, 100~240VAC
<b>Accessories</b>	
<b>Mount</b>	
V1664-W	Wall Mount, 316 Stainless Steel
V1664-C	Corner Mount, 316 Stainless Steel
V1664-S	Pole Mount, 316 Stainless Steel

**\*Note:** - 1) The pigtail cable is about 1.16m (from the outlet end to the end of the pigtail cable). Customers have to prepare the explosion-proof cable-protecting pipe. Please make sure that the length of the pipe satisfies the location needs. The pigtail cable includes power input, RS485, BNC, network output, GND, 2-ch alarm input, 1-ch alarm output, audio input and audio output.

2) "Confirmation of SD Card installation has to be notified with the Camera Purchase Order. Such confirmation if received on Order Readiness will attract additional cost. Please contact Infinova to know more".

## DIMENSIONS

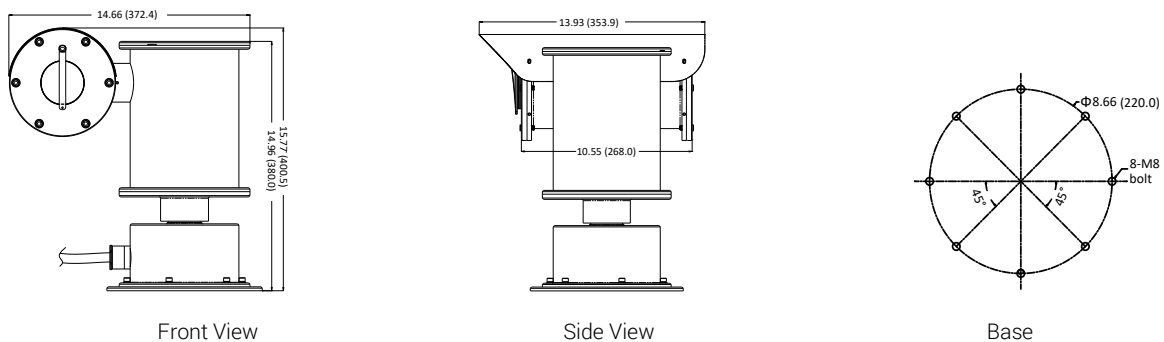

(Unit: inch, in the parentheses is mm)

# MOUNTING

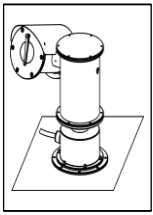

Surface Mounting

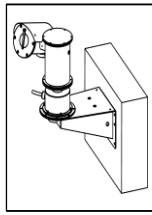

Wall Mounting

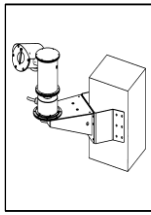

Corner Mounting

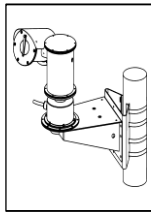

Pole Side Mounting

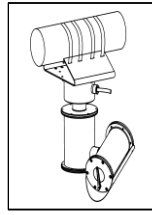

Pole Pendant Mounting

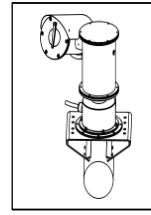

Pole Stand Mounting

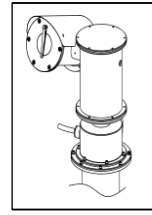

Pole Top Mounting

## V1664-W Mount:

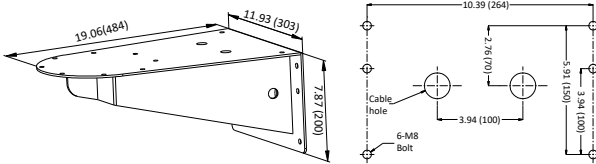

## Corner Mount Adapters for V1664-C:

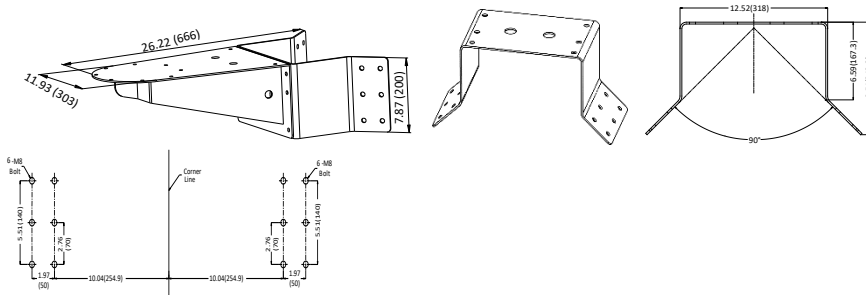

## Pole Side Mount Adapters for V1664-S:

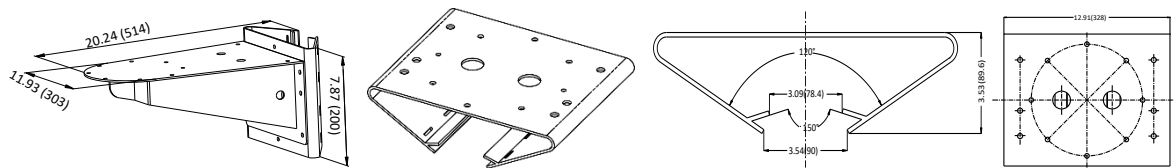

(Unit: inch, in the parentheses is mm)