

VH231-A2 SERIES

HD 2MP SMART STARLIGHT WDR IR IP PTZ DOME CAMERA

Infinova[®]

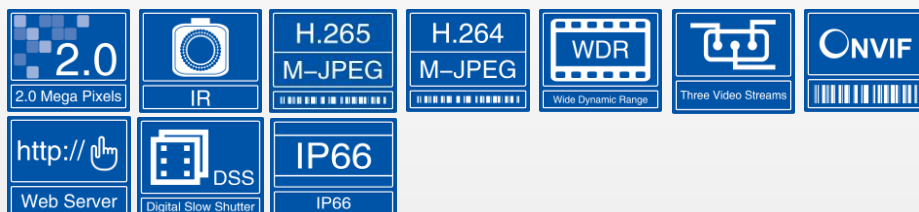

FEATURES

- Built-in 33X HD integrated camera module
- 1/2.8" progressive-scanning CMOS sensor
- ICR infrared filter automatic switching to realize true day/night surveillance
- Starlight-level ultra-low illumination: 0.0005 lux
- Embedded high-efficiency IR light with a wavelength of 850nm, ensuring long period time of stable use and reducing maintenance charge
- The night vision can reach 200m
- The output power of the IR light can be automatically adjusted according to the lighting intensity of a scene (Smart IR)
- Supports frame integration WDR, with dynamic range up to 132dB
- The maximum resolution is up to 1920×1080 @ 60fps
- Features smart functions to achieve border protection such as wire cross, intrusion
- Supports intelligent tracking
- H.265+M-JPEG or H.264+M-JPEG video encoding, three streams
- Supports internal storage
- Supports alarm recording and alarm snapshots
- Bi-directional audio, G.711-A/G.711-U/AAC standard optional (-W model)
- Two alarm inputs and one alarm output (-W model)
- Supports motion detection, 4 detecting areas dividable
- Supports Region of Interest (ROI), 8 regions dividable
- OSD Color optional
- Allows multiple users to perform live access and parameters settings via Web Server
- Supports preset, autopan, pattern, autoscan, time tour, normal tour, power-on return, etc.
- Supports ONVIF Profile S & G standard
- Supports RS485 control and analog video output for easy debugging
- IP66 protection rate, inbuilt a heater and air circulation system to avoid icing
- Supports remote network

DESCRIPTION

VH231-A2 series HD IR IP dome camera provides high quality video with the resolution up to 1920x1080@60fps, adopts H.265/H.264/M-JPEG compression formats, and boasts of excellent resolution and Color reproduction ability to ensure richer and more accurate details to be acquired and also guarantee the accuracy of intelligent analysis in a more effective way.

This product adopts large power LED infrared lamps, of 850nm infrared wave length, long night vision distance up to 200m and strong illumination. The IR lamps can turn on or off automatically based on environmental lighting conditions or can be adjusted manually. The IR illumination allows flexible adjustment so as to reduce IR lamp calorific value and extend its service life.

User-friendly GUI interface design allows users to perform dome PTZ control easily via network and to configure detailed camera parameters settings. At Web interface users can perform dome camera settings and operations by using a mouse which is more convenient than the traditional keyboard control. It also supports area zoom and image PTZ function.

VH231-A2 series dome cameras also feature general dome functions such as preset, pattern, autopan, autoscan, time tour and normal tour.

TECHNICAL SPECIFICATIONS

Lens (Visible)	
Image Sensor	1/2.8" Sony progressive scanning CMOS
Optical Zoom	33X
Digital Zoom	12X
Focal Length	f=4.6~152mm
Iris	F1.6~F5.5
Focus	Auto/Manual
FOV(H/V/D)	H: 62.10° ~ 1.88°; V: 36.83° ~ 1.09°; D: 69.10° ~ 2.17°
Lens Mount	-
Lens (Thermal)	
Imager Type	-
Lens Type	-
Spectral Band	-
Pixel Size	-
NETD	-
Focal Length	-
FOV	-
Video	
Camera Resolution (Visible Lens)	2MP
Camera Resolution (Thermal Lens)	-
Max. Coding Capacity (Visible Lens)	Major stream: H.265/H.264- 60fps@1920x1080 Minor stream: H.265/H.264- 30fps@1920x1080 Third stream: M-JPEG - 30fps@1920x1080
Max. Coding Capacity (Thermal Lens)	-
Data Rate	VBR/CBR Major stream: 256Kbps~10240Kbps Minor stream: 256Kbps~2048Kbps
Video Compression	H.265/H.264/M-JPEG independent coding
Multi-Streaming	Three stream independent output
Video Rotation	Video can be rotated by 90°, 180°
Audio	
Audio Compression	G.711-A/ G.711-U/ AAC
Sample Rate	8KHz (for G.711-A/G.711-U) 16KHz, 32KHz, 44.1KHz or 48KHz (for AAC)

Audio Interface	1 input, linear level, impedance: 1kΩ 1 output, linear level, impedance: 600Ω
Two-way Audio	Available
Mic & Speaker	-
Image	
Shutter	Auto/Manual (1/1~1/32000s)
WDR	Up to 132dB
Exposure	Auto/Manual/Shutter
Sensitivity	Color mode: 0.001 lux @ F1.6 (AGC ON) B/W mode: 0.0001 lux @ F1.6 (AGC ON); 0 lux (IR on)
White Balance	Auto/Manual/Outdoor
Video Adjustment	Brightness, contrast, saturation, chroma, sharpness
Noise Reduction	3D
S/N Ratio	>62dB
Defog	Available
EIS	Available
Mirror	Horizontal, Vertical
Corridor Mode	-
Day/Night Switching	ICR
AGC	Available
BLC	Available
HLC	Available
Privacy Mask	Up to 4 definable zones
ROI	Up to 8 definable zones
OSD	Supported
Pan/Tilt Functions	
Preset	1024
Pattern	12
Autopan	12
Normal Tour	16 groups (each tour can link to 14 actions, optional with Presets 1~32, Patterns 1~4 and Autopans 1~4)
Home Return	Available
Timing Tour	Available
Autoscan	Available
Area Zoom	Available
IR Illumination	
Smart-IR	Available
Wave Length	850nm

TECHNICAL SPECIFICATIONS

Night Vision Distance	200m
Temperature Measurement	
Screening Function	-
Measurement Distance	-
Measurement Range	-
Accuracy	-
Smart Analytics	
Video Analytics	Motion detection - Up to 4 detection areas Smart Video Analysis - Wire cross, area intrusion Intelligent Tracking - Rule-triggered tracking and manual-triggered tracking
Storage	
Storage Slots	Supports dual cards
Built-in Storage	Up to 512GB
NAS Storage	-
Local PC Recording	Available
Alarm	
Alarm Ports	2 alarm inputs, 1 on/off output
Alarm Input	I/O input, motion detection, intelligent analysis, SD card removal, network disconnection, heartbeat loss
Alarm Association	I/O output, email, FTP picture uploading, audio, SD card snapshot, SD card recording
System Functions	
Operating System	Win 7 or above versions
Browser	IE8 or above versions
Access Protocol	ONVIF Profile S & G, CGI
Multiple Access	Up to 5-ch simultaneous access
Web Server	Available
Remote Upgrade	Available
Password Protection	Available
RS485 Port	Supports, 1*RS485
Analog Video Output	Supports, 1*BNC port
Maximum Number of Users	32, with 3 types of users available: administrator, normal user, and operator

Wiper	-
Network	
Network Interface	1* RJ45 10/100M self-adaptive Ethernet port
Network Protocols	IPv6, TCP, UDP, IGMP, DHCP, FTP, SNMP (V3), SMTP, NTP, RTP, RTSP, RTCP, HTTP, HTTPS, TSL, SSL, QoS, PPPoE, DNS, DDNS, ARP, ICMP, UPnP
IP Address Filtering	Support blacklist and whitelist filtering
Network Delay	<140ms
Environmental	
Anti-Static	±8KV
Surge Protection	±4KV (Ethernet port, power port)
Operating Temperature	-40°F ~+140°F (-40°C ~+60°C)
Storage Temperature	-4°F~140°F (-20°C~+60°C)
Operating Humidity	≤ 95% RH
Environmental Rating	IP66
Impact Resistance	-
Mechanical	
Manual Speed	Pan: 0.1° ~500°/s; Tilt: 0.1° ~ 100°/s
Preset Speed	Up to 200°/s
Rotation Angle	Pan: 360°; Tilt: -8° ~ 90°
Preset Accuracy	<0.1°
Electric Motor	Stepping motor
Electrical	
Power Supply	24VAC/24VDC
Power Consumption	<54W (IR ON); <22W (IR OFF)
Physical	
Product Dimension (L×W×H) or (H x D)	14.28" × 8.9" (362.8mm × Φ226mm)
Package Dimension (L x W x H)	19.09" × 11.02" × 11.81" (485mm × 280mm × 300mm)
Unit Weight	10.80lbs. (4.90kg)
Shipping Weight	14.22lbs. (6.45kg)
Certifications	
Product Certifications	CE, FCC, IP66

ORDERING INFORMATION

VH231-A233-B361W	HD Megapixel IR IP PTZ Dome Camera, Starlight, WDR, Smart, 2MP, 33X, 1/2.8" CMOS, Day/night, H.265/H.264/M-JPEG, With audio alarm, Outdoor, Bracket mount, 24VAC/24VDC
Note: The installation bracket shall be purchased separately.	
Accessories	
Mount	
V1761H	Wall mount bracket
V1764H	Pendant mount bracket
Power Supply	
N3922-24D-3	AC to DC Power Supply, Plug-In, 230VAC, Output 24VDC, 3A
N3922-24A-3	AC to AC Power Supply, Plug-In, 230VAC, Output 24VAC, 3A

*Note: - "Confirmation of SD Card installation has to be notified with the Camera Purchase Order. Such confirmation if received on Order Readiness will attract additional cost. Please contact Infinova to know more".

DIMENSIONS

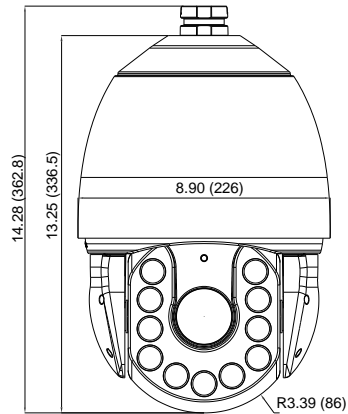

(Unit: inch, in the parentheses is mm)

MOUNTING

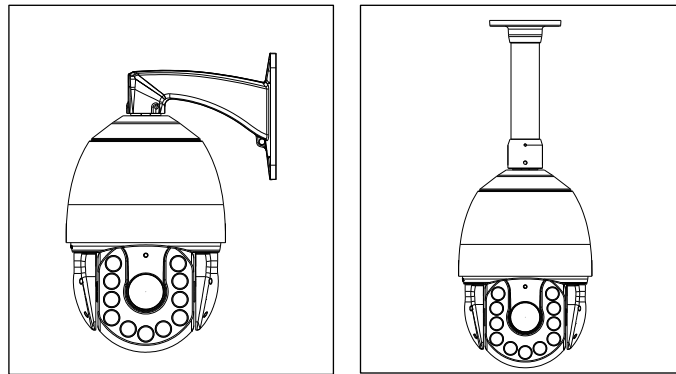

Wall Mount

Pendant Mount

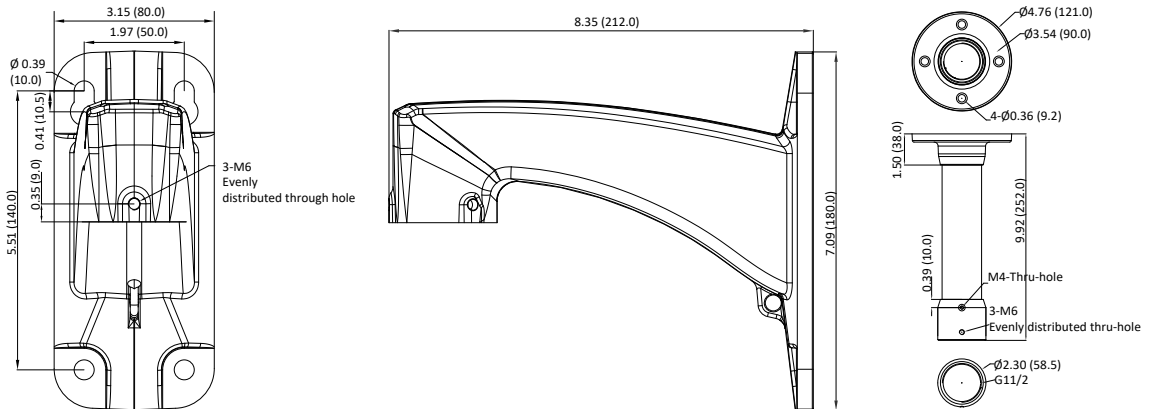

(Unit: inch, in the parentheses is mm)